

Online Testing Cell Systems



...Innovative testing solutions
made in Germany!



MonTech's RUBBER AND POLYMER TESTING SOLUTIONS AT A GLANCE

MonTech Werkstoffprüfmaschinen GmbH is the world's leading premium manufacturer of rubber testing instruments and laboratory solutions. Our extensive product range covers instruments for basic to high-end testing applications in quality control as well as research and development. This includes integrated laboratory software systems, technical and calibration services as well as world-class application support and consulting.

MonTech testing solutions are engineered and manufactured entirely in Germany according to the highest quality standards. Our products and services are available to customers in more than 53 countries worldwide with premier local support and assistance. All MonTech products are available in standard configurations, or can be adapted and built according to individual user requests and requirements.



→ MOVING DIE RHEOMETER & RUBBER PROCESS ANALYZER

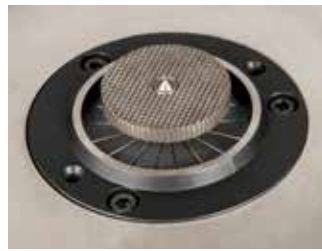

→ MOONEY VISCOMETER



→ DISPERSION TESTER



→ HARDNESS & DENSITY



→ PLASTICITY



→ COMPRESSION SET



→ MECHANICAL PROPERTIES

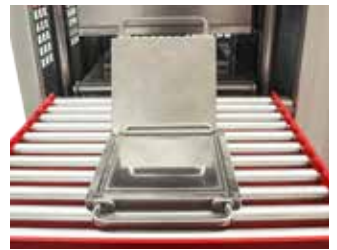

→ LABORATORY PRESSES



→ FATIGUE



→ SAMPLE CUTTERS + DIES

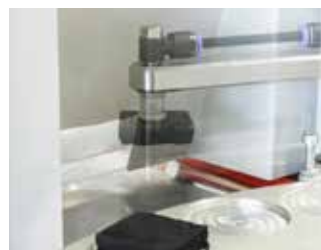

→ AUTOMATION SYSTEMS



→ BALE CUTTERS

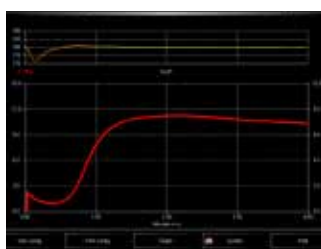

→ LABORATORY INFORMATION MANAGEMENT SYSTEM (LIMS)

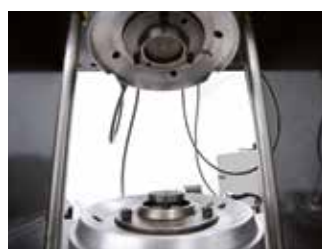

→ UPGRADES & REBUILDS



→ CALIBRATION, SERVICE & SUPPORT



ONLINE TESTING CELL SYSTEMS

The lean Industry 4.0 approach for completely automated quality control in rubber mixing plants

The following brochure is a introduction in the world of fully automated online testing which has revolutionized batch release testing over the past years around the world. Besides significant cost savings and shortest return on invest times, process engineers are - for the first time - able to create close loop control and real-time adaption of the mixing process resulting in an ultimate gain.

Partner with MonTech today to adapt online testing technology for your mixing plant and immediately benefit from its advantages!

Table of contents:

▶ Introduction	Page 04
Automated testing system for mixing line integration	Page 04
▶ Online Testing Integration	Page 05
▶ Cell System overview	Page 06
▶ Automated Sample Processing and Traceability	Page 07
▶ Layout and System Details	Page 08
▶ Cell interior layout and Components	Page 09
▶ Cell System Architecture	Page 10
▶ Robotic Handling System	Page 11
▶ Safety and Environment	Page 12
▶ Sample preparation Systems	Page 13
▶ Testing cell instrumentation	Page 14
Rheometers MDR & D-RPA 3000 Cell	Page 14
Density tester RD 3000 Cell	Page 15
▶ Maintenance and Accessibility	Page 16
▶ Sampling and Conveying Systems	Page 17
▶ Integration of Testing Cells	Page 18
Mixing line integration	Page 18
System Integration	Page 19
▶ Sequence of Operation	Page 20
Testing methodology and procedures	Page 21
▶ Return on Invest Calculation	Page 22
▶ Engineering and Customization	Page 23



MonTech ONLINE TESTING CELL SYSTEMS

AUTOMATED TESTING SYSTEM FOR MIXING LINE INTEGRATION

MonTech is the world's leading manufacturer of integrated rubber testing systems. With more than 30 years of engineering experience and 100+ fully automated Testing Cells installed, our testing solutions are designed for the specific testing and integration requirements for each customer or mixing line type. Based on MonTech's field-proven automation technology, the Online Testing Cells are tailored to for seamless integration into mixing lines and existing control and host-systems.

All MonTech machines and Testing Cells are entirely engineered and manufactured in Germany while closely supported through our global service and support network.

Batch release and quality control testing in rubber mixing plants: traditional laboratory vs. Online Testing Cells

Traditional lab testing setups contain instruments for quality control and batch release located in designated testing laboratories or in close proximity to the mixing lines. Each machine can be equipped with automated sample handling systems and partially integrate into the batch release process through data interfaces for automated feedback.

The number of instruments required in a traditional laboratory highly depend on sampling frequency, test type, and the duration of each test performed. Laboratory operation requires a substantial number of operators retrieving samples from the mixing line, identifying samples, preparing test specimens and loading the instruments. This causes severe limitations in productivity and does not guarantee response or handling times.

Although laboratory instruments outfitted with automation can improve productivity, the testing and quality control process relies heavily on operator involvement, introducing variability into the testing process and results.

Online Rubber testing cells bring the laboratory to mixing line by linking the necessary MonTech standard testing instruments into a single, compact, and modular enclosed frame for easy installation on the production line. Designed per user requirements, modular emplacements include, labeling, binning, sample conditioning, sample preparation, specimen removal, transportation, and testing instruments. Each Testing Cell consists of single or multiple testing instruments of similar or different purpose required for batch release.*

Online Testing Cells completely remove operator involvement from the testing process by applying robotics. Producing better quality control, Testing Cells are equipped with extra instruments into the frame for higher testing throughput and data consistency.

MonTech Online Testing Cells utilize the latest robotic technology for sample handling, preparation, and processing, allowing the system to operate independently of operator involvement.

Rubber testing cells are software controlled and interface to host systems such as mixer controls, Batch-off PLC, ERP and CRM systems, Web-based monitoring interfaces, data viewers, Laboratory Information management systems (LIMS), Statistical process control (SPC) software, MES, Mixer Controls, auxiliary production machines, and more.

All devices and instruments installed in an Online Testing Cell are programmed and controlled by a single industrial computer - fully replacing the individual instrument PCs. This centralized workstation also acts as the communication master and coordinator for the PLC controller for all automation functions of the Testing Cell.

In MonTech Testing Cells, all integrated instruments are easily accessible and serviceable. All instruments can be utilized independently of the rubber Testing Cell, linked automation, or software interface systems.

** Online Testing Cells systems and their technology are based on several global patents held by the MonTech group of companies*

ONLINE TESTING INTEGRATION

Instruments and systems for Testing Cell integration:

MonTech Online Testing Cells are equipped with a configurable set of standard devices for sample handling and preparation, with additional instruments to cover the individual throughput and test requirements for any mixing line.

All instruments in Online Testing Cells are based on MonTech's reliable rubber testing instrument technology with each instrument adapted for seamless integration into any fully automated testing system. These adaptations include automatic handling accessibility for shorter handling times, increased capacity for testing film, and fast-access for service and preventative maintenance.

Standard cell configuration for sample handling and preparation:

- Sample infeed system including infeed chute, centering system and sample detection unit
- 6-Axis robot with multipurpose gripping and handling system
- Cell controller with MonCell Software and 19" Industrial Touchpanel PC
- Cell communication and safety controller
- Sample washing, conditioning and drying unit
- Volumetric sample cutter: R-VS 3000 cell edition (Slab measurement, nicking and volumetric cutting)
- Five sample manual infeed drawer
- Leftover slab trash container
- Sample collection drawer

Optional units for cell sample handling and preparation:

- Separation of the individual test slab in different containers
- Discarding of the leftover raw slab in separate collection containers
- Weighing of test specimens
- Label or ink-jet printing system for sample marking
- Batchoff sampling systems, cutters and conveyors

Available test instrument types:

- Moving Die Rheometers MDR 3000 Cell (with direct or mechanical drive system), up to 4 units per Cell
- Rubber Process Analyzers D-RPA 3000 Cell, up to 2 units per Cell
- Compression Density testers RD 3000 Cell, up to 1 unit per Cell
- Additional instrument types include: curing presses, hardness, density, rebound, DMA, etc.

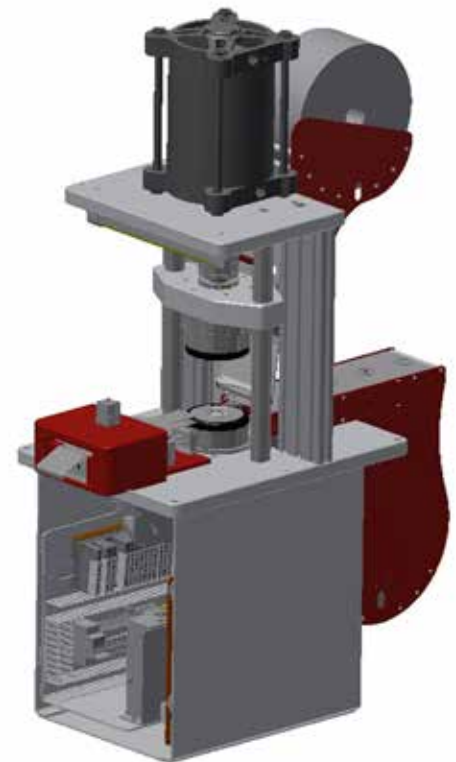

MDR 3000
Cell Edition

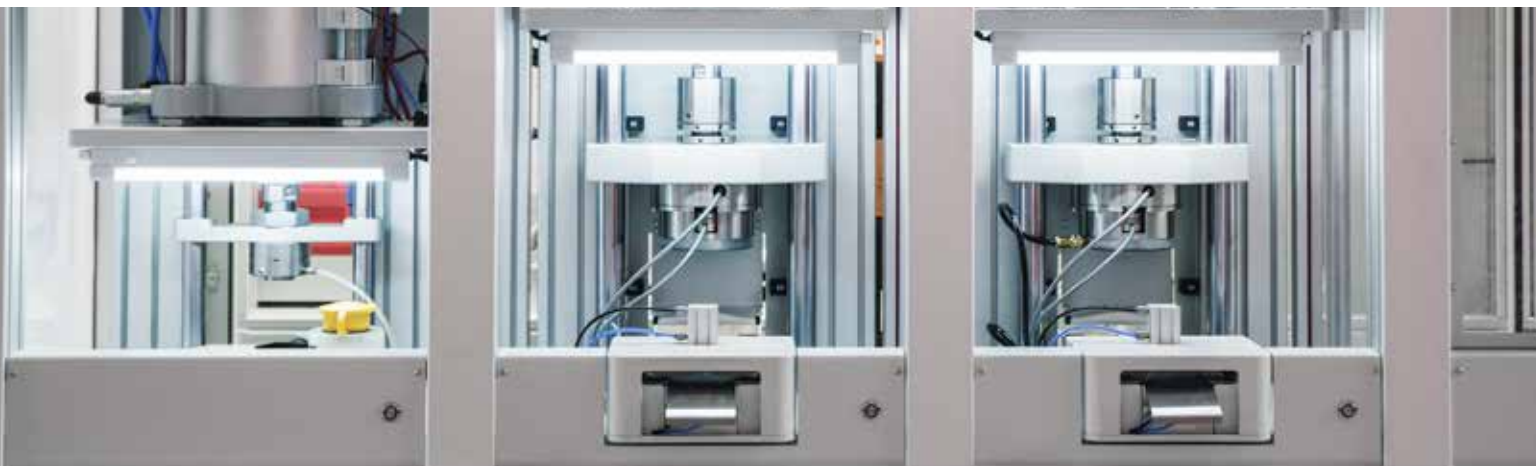

MonTech ONLINE TESTING CELL SYSTEMS

ONLINE TESTING CELL SYSTEM OVERVIEW

Online Testing Cells are state-of-the-art automated testing solutions that provide maximum efficiency and the shortest ROI times. By installing Testing Cells at the production line, manufacturers can achieve maximum throughput, tighter quality control, decreased laboratory overhead, and less scrap.

Rugged and reliable technology:

MonTech Testing Cells are a complete batch release laboratory on a 2.0 by 2.3 meter footprint. With flexible configuration, Testing Cells contain each element of the laboratory QC process within its pressurized housing.

Online Testing Cells feature a sealed and supervised testing environment preventing any contaminants from entering the system. The cells are based on a rugged welded main frame providing one large main compartment for the automation technology, and sample preparation systems, and the robotic handling system. This main working area of the Testing Cell is accessible by two large walk-in maintenance doors.

The Cell frame has four smaller compartments that allow for user required test instrument placement. These instrument compartments are completely separated from the main working area, allowing for easy maintenance accessibility and manual operation - even while the rest of the Cell and robot remains operational. Every compartment features an overhead hatch for hoisting instrument into and from the Cell enclosure.

Located on the side of the Cell, a centralized workstation acts as a communication master and coordinator for the PLC controller. This console comes equipped with a 19" control screen, and pushbuttons for main cell functionality (start, stop, safety, etc.).

The main Cell PLC, robot controller, IP-based communications system are located behind the control workstation, in a separate, air conditioned cabinet.

Below the workstation, a utility compartment houses the Cell's central connection points for compressed air, water, and drain.

For fully automated operation, Online Testing Cells are linked directly to the production machinery including the mixer, batch-off unit, and roller-head die. Different inlet points and heights are available to feed raw slabs into the Testing Cell. Raw slabs are typically 100mm (4") diameter and taken at the batch-off by the roller-head die.

Slab conveying systems can be supplied by MonTech along with the Testing Cell as a turnkey solution.



AUTOMATED SAMPLE PROCESSING AND TRACEABILITY



Online Rubber Testing Cells feature robotic automation and eliminate the need for any operator involvement. By applying robotics, administrators can monitor and control production in real-time without needing a separate QC or testing laboratory.

All necessary steps to process the raw slab are selected according to the control plan and automatically executed by the Testing Cell.

This includes:

- Receiving, detecting and aligning of the raw slab
- Washing, conditioning, cooling and drying of the slab
- Slab measurement, nicking and volumetric cutting
- Separation of the individual test specimens
- Weighing of test specimens
- Feeding of the test samples directly into test instruments or sample queues of e.g. MDRs, RPAs, Density testers, ...
- Discarding of the leftover raw slab in a separate waste container

Sample traceability is guaranteed at all times as the automation system processes each slab sequentially. After all preparation steps are successfully completed, the robot will begin the preparation process for the next slab.

Additionally, Testing Cells can collect binned samples for testing done outside of the Cell. To ensure traceability, binned samples can be either labeled or ink-jet printing can be applied on the raw slab. These collection bins are accessible by a drawer system from outside the Cell allowing operators to collect and pick up lab test samples at any time.

Each Cell comes equipped with a manual sample in-feed drawer. This drawer enables users to manually feed control stocks, reference materials, and scheduled test orders into the Testing Cell.

MonTech ONLINE TESTING CELL SYSTEMS

SYSTEM LAYOUT DETAILS

Since the introduction of the Online Testing Cell by MonTech in 2010, these automated systems are now considered to be the market leading solution for mixing line quality control in the rubber industry.

The front of the Testing Cell structure contains the access points for each of the four instrument compartments. The adjacent side contains the main control panel, and the safety-locking maintenance access door. The top of the Cell is outfitted with the in-feed conveyor, sample in-feed chute and the status signal tower.

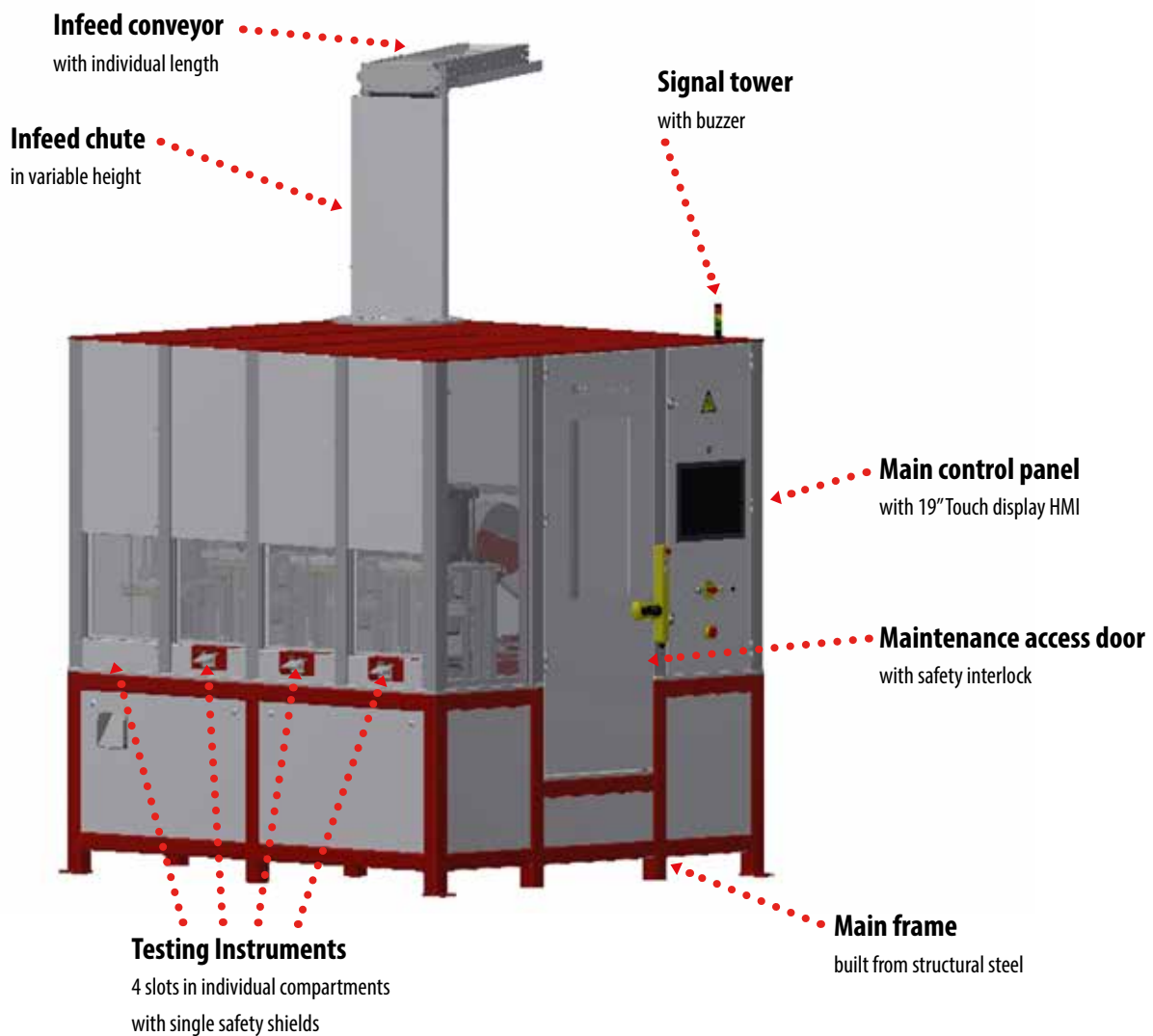

The main control cabinet of the testing cell is equipped with air conditioning and is sealed with positive pressure. Strict airflow pattern is maintained in the control cabinet to efficiently cool all electrical components for reliable operation in temperatures up to 45°C. Positive pressure generated is then distributed to the interior of the Testing Cell, keeping the sample processing area clean at all times.

CELL INTERIOR AND COMPONENT LAYOUT

The interior of the Testing Cell is designed to keep safety, easy accessibility, and quick serviceability in mind:

Two large walk-in maintenance safety doors are installed on either side of the Testing Cell. This allows for quick and easy access to all Cell internal modules and components. Uptime for Online Testing Cells can be in the range of >99.8%. The modular design allows for different sub-systems to be added or removed in minutes, guaranteeing maximum uptime and availability of the system.

Below is an example of a typical Online Testing Cell found on a silica final mixing line:

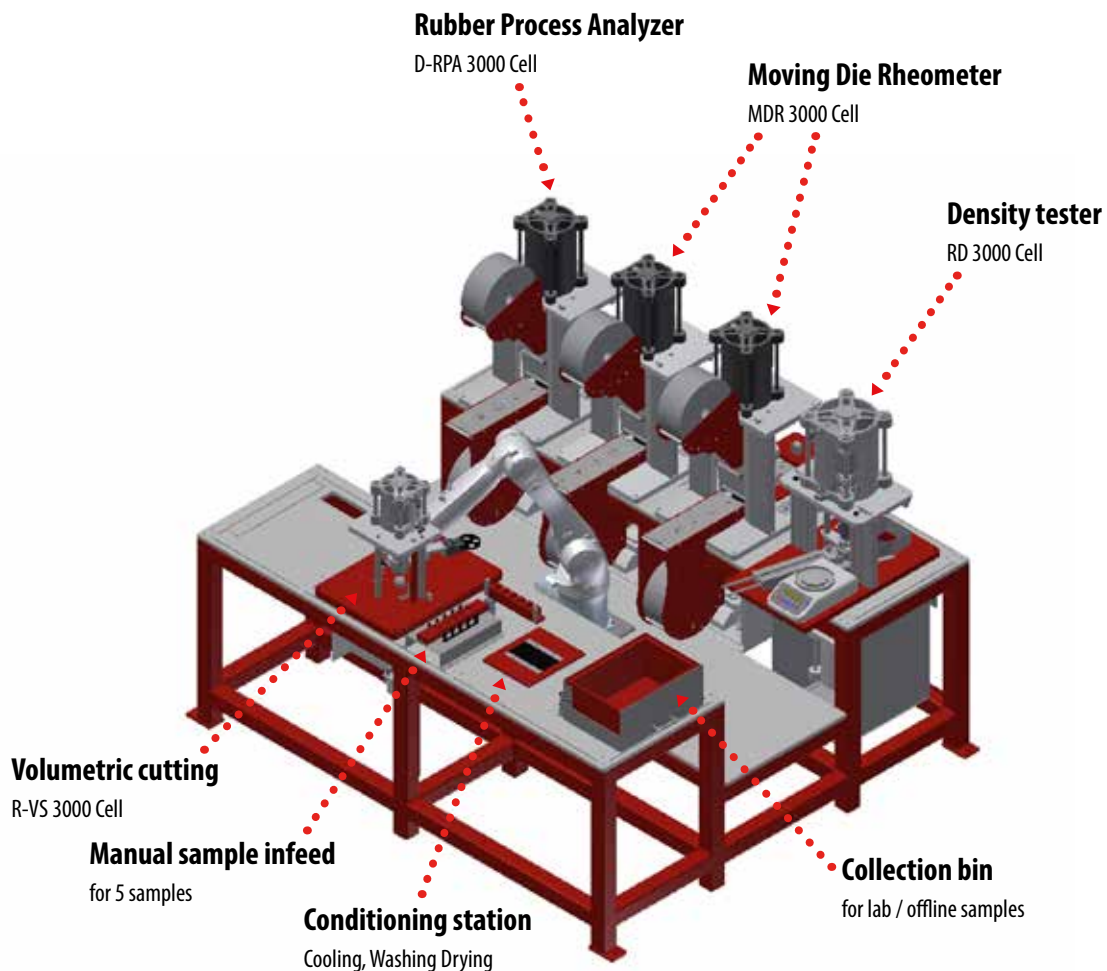

MonTech ONLINE TESTING CELL SYSTEMS

CELL SYSTEM ARCHITECTURE

The backbone of each Online Testing Cell is a modern multi-layer software design, aggregating the Test Cells into several functional units for quick connectivity and future adaptability.

The proprietary Testing Cell software architecture consists of a Cell Master PLC for all high level tasks and a 19" touch panel for direct feedback. MonCell software consistently coordinates all instruments, Testing Cell systems, and test configurations.

The Cell programmable logic controller (PLC) monitors all control tasks and critical safety functions in real time. All testing Cell communication is based on industrial TCP/Ethernet communication for highest data rates and communication consistency. This also allows a seamless integration of additional sub-systems while providing direct connectivity to any external host system - such as MES, LIMS, ERP, Batch-off software, or other systems.

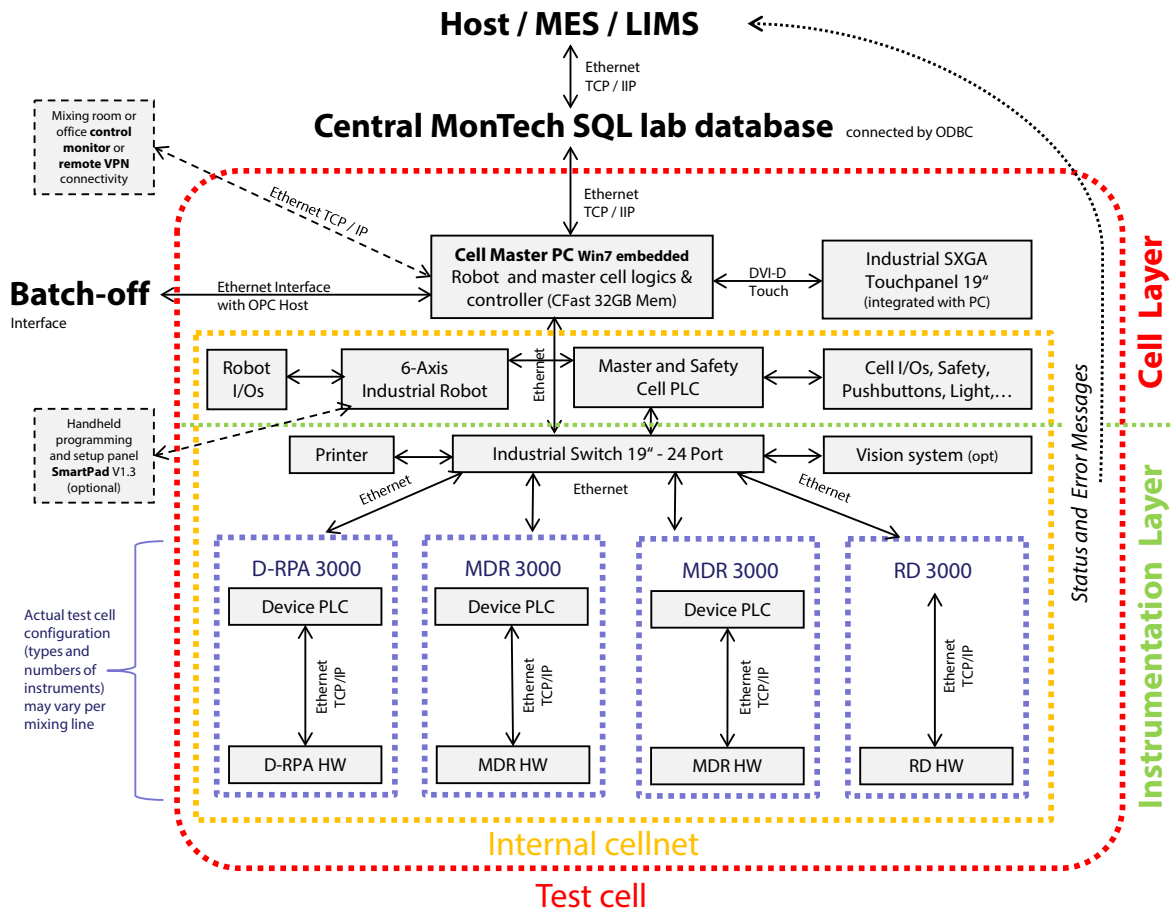

Optional Testing Cell control monitors are available for installation in mixing rooms, offices, or laboratories, enabling users to monitor Cell status and batch-release progress. Mobile applications and remote diagnostic solutions are also available.

ROBOTIC HANDLING SYSTEM

Robotic handling solutions are integrated into every Online Testing Cell, achieving the high productivity rates for the testing process.

The core component to each Testing Cell is a highly precise, reliable and extremely fast 6-Axis robot system. The robot is positioned in the center of the Testing Cell with access to all critical sampling areas and testing sub-systems. In order to excel with the large variety of tasks, the robot is equipped with a multi-functional handling arm. Processing and handling samples is done with multiple sets of mechanical grips, combined with vacuum gripping, for easy transportation. Additional tasks covered by the robot include labeling on the raw slab, collecting samples for lab testing, sorting bins and disposing of scrap material.

Robots do not require re-programming as every testing sequence is pre-configured and thoroughly tested. Additionally, integrated troubleshooting routines allow the Testing Cell to return to control states without user involvement.

If test requirements, or sub-systems must be changed, robotic handling sequences can be adapted to any requirement or any additional task. To ensure traceability of all tests, the accurate control technology of the robot is synchronized with the Testing Cell controller. The Cell monitor displays robot/Cell synchronization status and diagnostic messages.



MonTech ONLINE TESTING CELL SYSTEMS

SAFETY AND ENVIRONMENT

Ensuring worker safety is the top priority of all Online Testing Cells.

The Testing Cell is divided into clearly separated functional areas with individual safety requirements, physically separating operators from any dangerous areas of the unit or its sub-systems. Sub-system states are clearly marked, informing operators of testing statuses and machine conditions. Sub-system states are clearly marked, informing operators of testing statuses and machine conditions.

Safety measures, including coded door handles, door interlocks, emergency shut-off buttons and automatic stopping software features prevent operators from physically entering any dangerous access point. Dual dedicated monitoring channels ensure safety states of testing machines and Cell modules are active at all times.

All Testing Cell configurations comply with latest machinery safety directives, including OSHA standards and practices resulting in a documented performance level E safety directive. Additionally, documented performance level E directives and risk assessments are supplied with all Testing Cells.

Sealed environment for reliable operation in a mixing room:

In order to protect the Testing Cell interior from outside contaminants including dust, dirt, and carbon particulates, each unit is completely sealed and pressurized. Combining these features with the fanless electronic design of every Cell ensures a clean working environment for all interactions within the Cell structure.

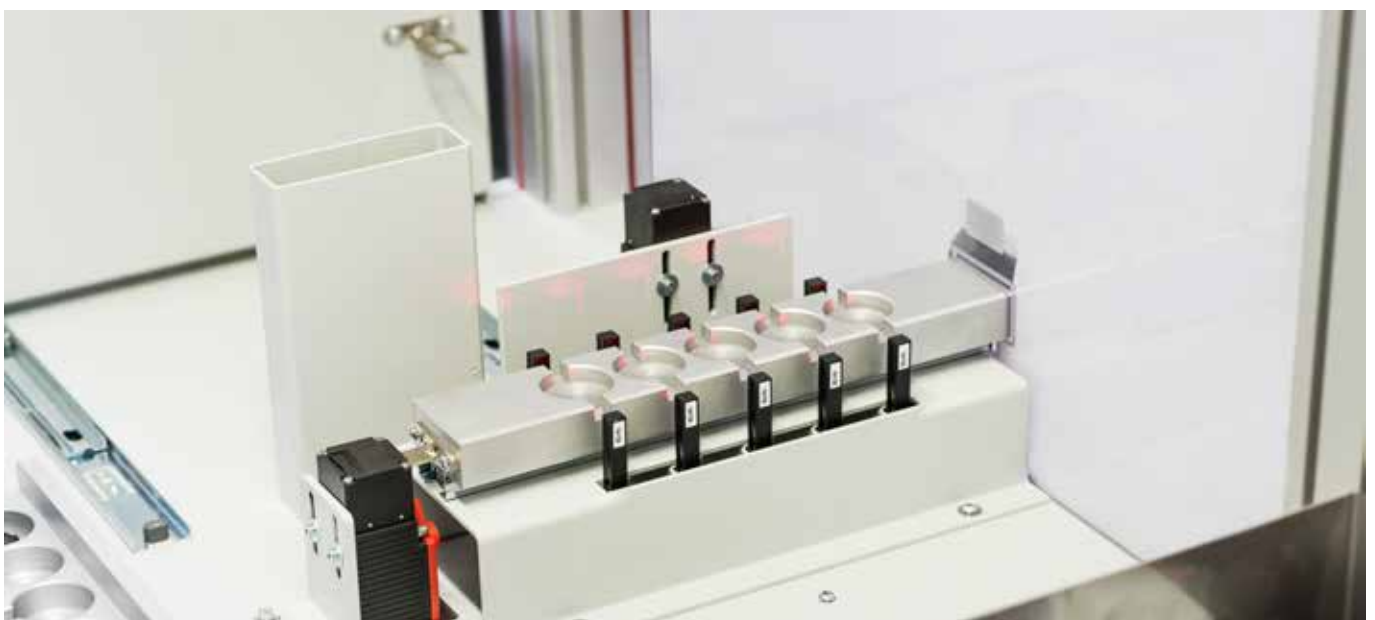

SAMPLE PREPARATION SYSTEMS

Online Testing Cells guarantee highest reproducibility using volumetric sample preparation.

Once the test specimen enters the Online Testing Cell, the sample is conditioned and volumetrically prepared for continued testing. Slabs entering the testing Cell must be a diameter of 100mm (4") and +/- 2.5mm for uniformity. Approximately three to four testing samples can be cut and extracted from each supplied slab (other slab dimensions are available upon request). Optionally, camera based vision systems installed in the Cell can measure raw slabs, or non-uniform samples, for dynamic robotic alignment.

To ensure traceability, all specimens are delivered to the testing machines with FIFO priority as defined by the control plan. Samples are accurately prepared for every test order specified in the control plan.

MonTech's optical sensor technology, installed directly on the robot, precisely positions the mechanical multi-grip. The multi-grip contains a variety of tools for gripping samples and completely eliminates user involvement to change grip types.

The automated sample preparation system can be bypassed by the integrated manual drawer. This slide-out module allows 5 pre-cut samples to be introduced to the Cell - ideally suited for control compounds or reference checks.

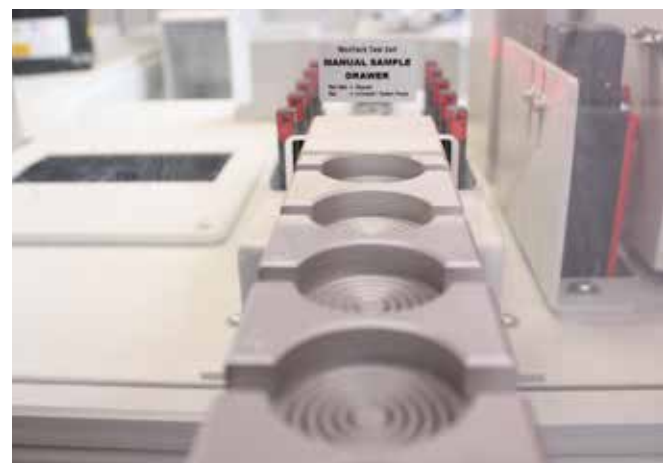
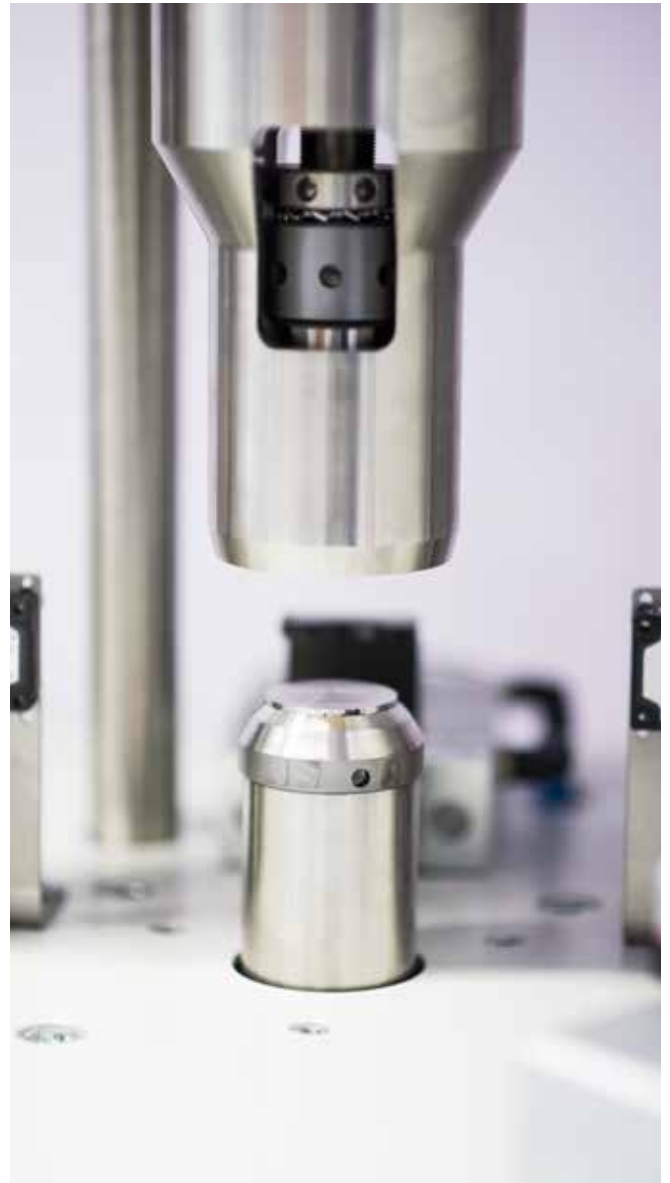

MonTech ONLINE TESTING CELL SYSTEMS

RHEOMETERS MDR & D-RPA 3000 CELL

The moving die rheometers (MDR), including the rubber process analyzer (RPA), are based on the reliable design of the MonTech laboratory testing instrument series, refined and adapted for complete automation and easy integration into the Cell structure.



Standard rheometer configuration for all Testing Cells include MDRs and RPAs with a 5 sample linear automation system. The linear tray serves as a dedicated testing queue, disabling any interruption to the control plan or Cell operation. Linear autoloaders for cell instruments are quipped with individual sample sensors ensuring full sample traceability.

To improve testing performance, Cell-type rheometers are fully integrated into separated compartments in the Cell frame and linked to the Cell's safety system. This compartmental design provides superior accessibility for the robot and consumables.

Each Cell-type rheometer uses high-capacity consumables for long, uninterrupted operation times. This includes, long life die seals, and high capacity film rolls.

Results obtained from any Cell-type instrument are equivalent to results found in the laboratory. Therefore, each user can maintain and operate within single set of tolerance points for testing done with a Cell or in a laboratory. Instrument options including pressure measurement, die gap control, and low temperature cooling are also available for Rheometer implementation.

The shielded compartment separates each Rheometer, allowing them to be easily accessed, calibrated, and serviced while other instruments remain undisturbed. While one instrument is being serviced, the robot intercepts samples and distributes them to alternative machines or bins them for lab testing.

Rheometers found within the Testing Cell are equipped with the same style PLC-based industrial control platform with direct ethernet connectivity for fast data processing to external LIMS, SPC and reporting systems.



DENSITY TESTER RD 3000 CELL

The Cell-type RD 3000 is the only available fully automatic compression density tester for uncured rubber compounds and polymers.

Specifically for use in Testing Cells, MonTech has adapted the RD 3000 compression density tester for completely automated operation. This includes draft-shielded sample weighing, sample feeding, test sequence running, volumetric sample preparation and disposal.

The Cell-type RD 3000 features automated lubrication and cleaning, eliminating any need for frequent maintenance. The fast, easy, rugged and reliable process for obtaining bulk density results is unrivaled in accuracy and control.

A compression density test cycle consists of the following steps:

- The 100mm raw slab is received by the testing cell and is cooled / washed
- Two samples, about 35mm in diameter are cut from the slab
(of course additional or other samples for e.g. MDR or RPA could be cut from the same slab as well)
- Sample weights are individually measured
- Samples are placed in the compression cylinder
- Samples are compressed to an air-free state and volume is measured.
- Based on weight and volume the density is calculated
- Sample is ejected from the compression cylinder automatically
- Compression cylinder is cleaned and lubricated automatically

After the completion of each test sequence, all test data and results are sent to the Cell control computer where a Pass / Fail status is immediately calculated and reported.

Verifying and calibrating the weighing system can be done in seconds.

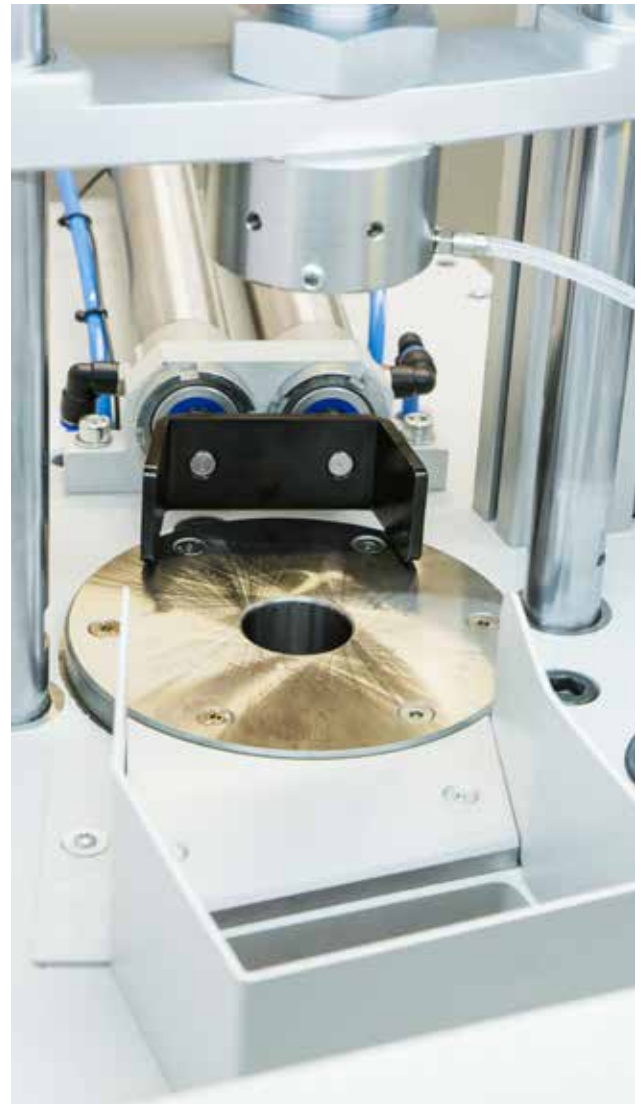

With easy to use components and maintenance procedures, the Cell-type compression density tester is the new benchmark for automated, accurate, and repeatable density measurements on rubber compounds.

MonTech ONLINE TESTING CELL SYSTEMS

MAINTENANCE AND ACCESSIBILITY

With over 20 years experience in the design and production of testing equipment, MonTech manufactures the most reliable testing instruments in the rubber industry.

Online Testing Cell design advantages for superior reliability, easiest maintenance and accessibility include:

- Longlife consumables, including seals, testing film, and automated lubrication guarantee long duty cycles and minimal maintenance effort
- Stainless steel mechanics and direct drive technology in all systems
- Industrial standard 24V DC control voltage with de-centralized supply (optional with UPS integration)
- Physically and logically separated sub-systems ensure that system irregularities do not affect other sub-systems keeping the testing cell operational
- Every input, output and communication channel are represented by green, yellow, and red status indicators
- Dedicated service screens display clear and easy notifications of system irregularities and troubleshooting directions
- All system and robotic configuration is done through menu-guided control screens in MonTech's MonCell software system
- Quick swap design allows users to replace sub-systems or even complete instruments in minutes with hot-plug functionality



Rugged and reliable industrial control technology:

MonTech Online Testing Cells use the most reliable, and proven components. All Testing Cells utilize industrialized electronics and technology in each sub-system, eliminating expensive custom made replacements and promising highest dependability and minimal service efforts. Slide-out maintenance panels guarantee easy access to every component.

Utility handling:

Each sub-system has a separate utility cabinet, enabling easy-access and quick independent servicing. All sub-system components are integrated onto a single subplate with clear markings for all media types. Additionally, integrated diagnostic points and a dedicated service screen allow effective troubleshooting with specific maintenance user levels.



SAMPLING AND CONVEYING SYSTEMS

Delivering suitable samples to an Online Testing Cell is vital to implementing fully automated testing:

While mixed compound is processed into, or after batch-off, slab samples must be taken at predefined positions or times. To increase the confidence level of test results, oversampling of slabs is recommended for additional testing within the Cell.



Cold Sampling systems

Cold sampling systems are located before the material stacker, just after the material exits from the batch-off. These systems cut and extract a 100mm slab sample and transport it to the Cell. All raw slab samples diameters are precisely defined for easy transportation, however, volumetric sampling is required due to the varied thickness.

Slab cutting systems, whether pneumatic punchers, mechanical cutters, or any customer specified cutter, can be supplied by MonTech or in cooperation with the current batch-off supplier.

Hot sampling systems:

Rotary, wheel-type sampling systems are recommended as the conveyor movement cannot be slowed for sample taking.

Any type of sampling system is closely integrated with the batch-off controls for full batch and material traceability. Various designs of cold and warm sampling systems are available, allowing flexible adaption to almost any environment. Sampling systems can also be outfitted with productivity options such as inkjet printers, feeding conveyors, sample lifters, and more.



MonTech ONLINE TESTING CELL SYSTEMS

MIXING LINE INTEGRATION

Online Testing Cell mixing line integration:

MonTech Online Testing Cells can be integrated into existing mixing lines or incorporated into greenfield projects. Cells can be specified for installment on traditional mill mixing lines or modernized mixing lines, featuring twin-screw extruders and roller head dies. All mixing lines considering the addition of a Testing Cell must be equipped with sampling devices. Users must then choose to acquire the sample hot, at the infeed into the batch off or cold at the end of the batch off.

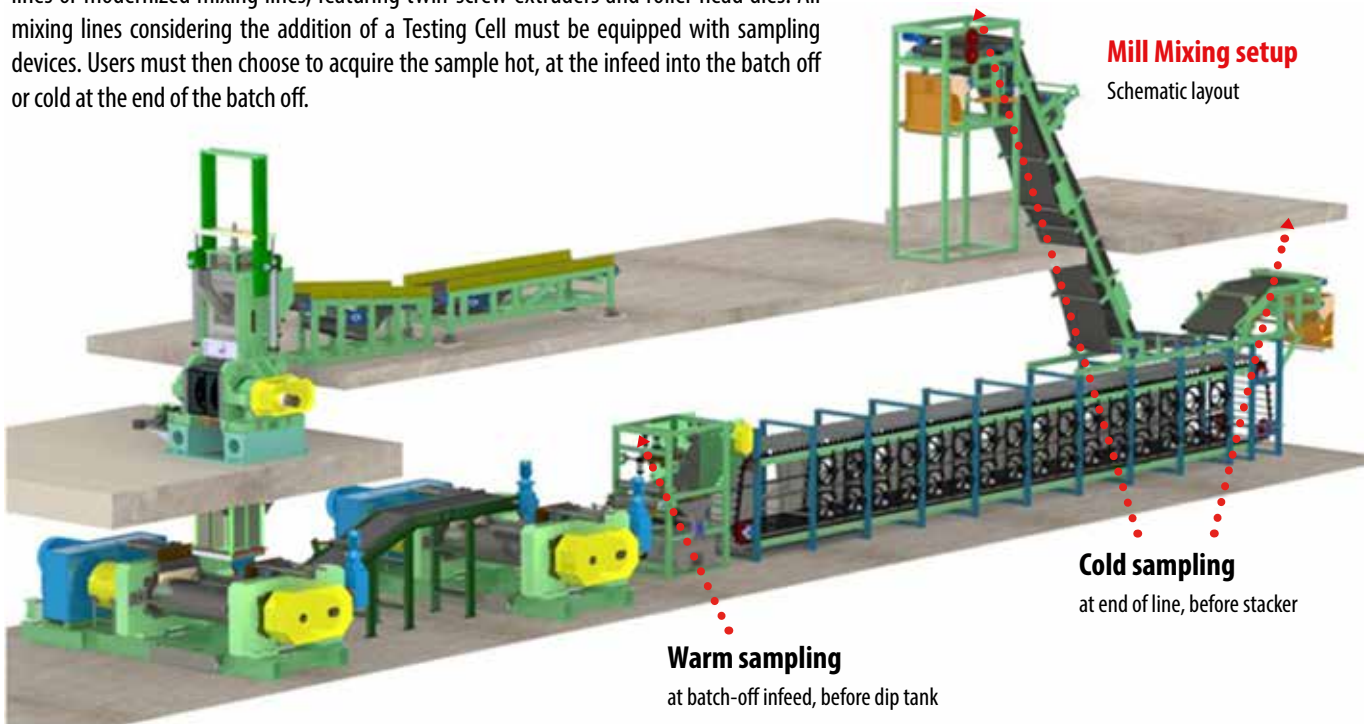

The sampling methodology selected will impact the test results obtained and the workflow of the quality control process. Therefore, Cell implementation projects must first carefully consider and select the appropriate sampling point:

Hot Sampling: Sample slab is taken between twin screw extruder and the dip tank

Cold Sampling: Sample slab is taken upon exit from batch-off and before the material stacker

For higher flexibility, Testing Cells can be equipped with a dual inlet feeders for simultaneous hot and cold sampling.

Hot Sampling

Advantages:

- Quick & immediate feedback
- Short reaction times
- No sample contamination

Disadvantages:

- No 1:1 re-testing possibility
- Batch-off influence
material cooling and relaxation not considered

Cold Sampling

Advantages:

- Re-testing is easy - short reaction times
- Testing results reflect
compound properties

Disadvantages:

- Long delay between actual mixing and testing
- Anti-Tack / release agent contamination

SYSTEM INTEGRATION

Online Testing Cells form an integral piece of the mixing line and production/software workflow:

For every Testing Cell, MonTech offers a variety of standard interfaces based on common industrial automation standards and practices. Specific Cell projects can be adapted or customized to customer requirements or existing infrastructure.

Implementing an Online Testing Cell requires examination of mixer configuration, spacing requirements, and sampling possibilities. All integration projects are tailored for customer specifications and include the following points:

- Checking, adding or modifying an automated sampling device for 100mm diameter (+/- 2.0mm) for hot or cold sampling
- Conveying, detecting and buffering systems for transporting the raw slab sample to the Testing Cell
- Space allocation for physical placement and integration of the Testing Cell in the mixing room environment
- Data and host connectivity with dedicated communication interfaces to:
 - Lab Information Management System (LIMS)
 - Host Systems / ERP
 - Mixer / MES
 - Other user specified interfaces
- Utility connections including:

● Electrical supply	(typ. 3ph, 400-480V, 50/60Hz, 16 Amps with Ground and Neutral)
● Compressed air	(min. 6 Bar / 90 psi, 600l/min / 160gpm)
● Water	(min. 2 Bar / 30 psi, 50l/min / 13gpm)
● Drain	(typ. 1") (in case of water or drain connections not being available re-circulating chiller system can be offered and integrated)

Twin-Screw setup

Schematic layout

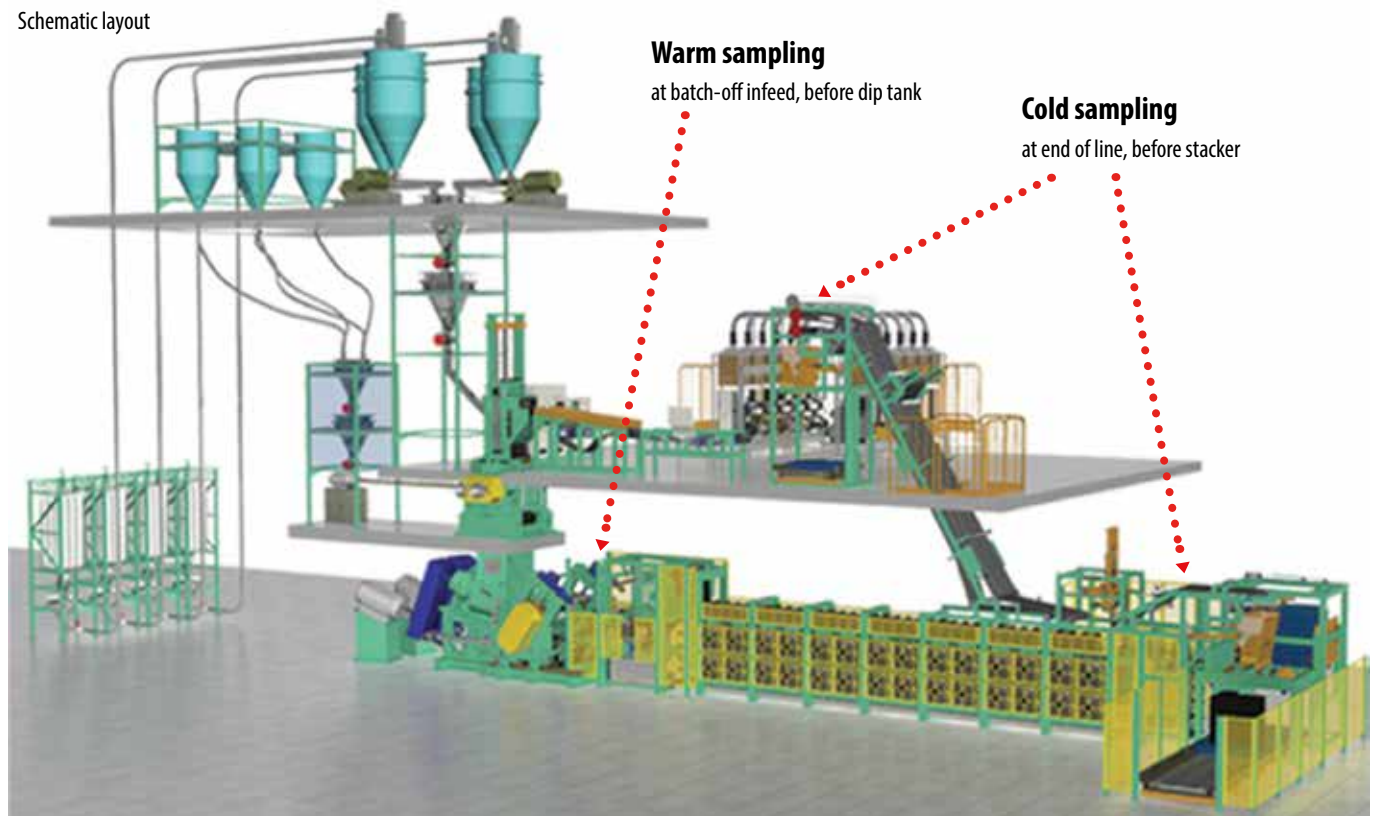

MonTech ONLINE TESTING CELL SYSTEMS

SEQUENCE OF OPERATION

Automating the quality control testing revolutionizes the production process:

Applying robotics decreases operator variation, and increases the precision and repeatability of batch releases in the quickest response times. The closed loop control of mixing, testing, and host data interfaces provided by the Cell allows users to fine tune and optimize all processes together. The control plan can dynamically adapt or react to events during the mixing process (i.e. scorch properties from high temperature mixing, degree of silanization from mix energy). The diagram below displays Online Testing Cell automation Vs. the traditional lab:

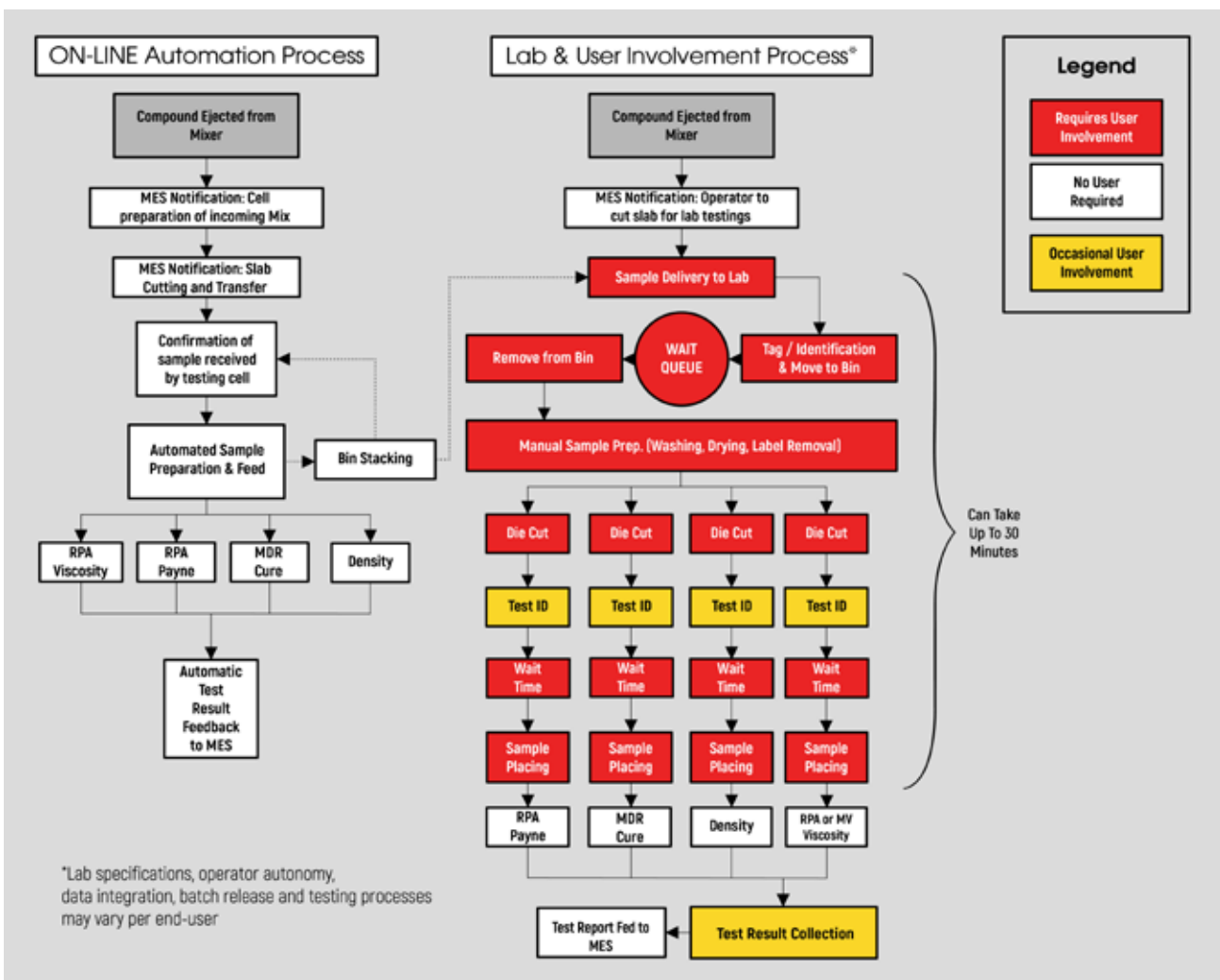

Alongside the reduction in labor costs, time required for specific Pass/Fail batch release data is reduced by 62% to 80%. All Testing Cell's collect the optimal amount of data from up to three samples taken per batch to make all relevant production decisions. Acquired data, and host system statuses can be monitored directly by mixing control rooms, laboratories, manager offices, or VPN access.

TESTING METHODOLOGY AND PROCEDURES

The testing flexibility and adaptability of all Online Testing Cells create the foundation of a “Smart Rubber Factory:”

With MonTech Cells, users can initiate and modify control plans/test procedures for agile quality control, while predicting material processability and final product performance. The type of mixing line, cycle time, and compound produced are taken into account during Cell development, ensuring instrument selection and control plans are optimized for Industry 4.0 manufacturing.

Example test methods and procedures:

Once testing methods and procedures are selected by the user, they are adapted for optimized testing times within the Cell. MonTech will expertly recommend sampling and testing frequencies based on mixing line type, setup, compound recipes and quality requirements.

Procedure	Standard / Reference	Method Description and Purpose	Cycle time	MDR 3000 Cell	D-RPA 3000 Cell	RD 3000 Cell
Cure testing	ISO 6502, ASTM D 5289, DIN 53529	Rapid rheometer cure testing ensures active components are incorporated into the mix and that curing and processing properties are within limits.	~ 2 - 4 mins	up to 3 samples per batch	(can also be used for cure testing)	
Compression density	Industry Standard	Compression density testing predicts variations in filler dosing by rapidly measuring volume and weight of each rubber compound.	~ 1 - 2 mins			typically 1 per batch
Payne effect (uncured / cured)	Adapted ASTM D 8059	The Payne Effect test measures the unvulcanized or vulcanized dynamic strain softening, filler-filler interaction and assesses the degree of silanisation in the mix, ensuring that chemical mixing reactions are successful.	~ 4 - 14 mins		every silica masterbatch	
Carbon Black Dispersion Index	Industry Standard	CBDI tests rapidly assess carbon black micro-dispersion by measuring the recovery of Van-der-Waals forces over time, indicating the filler network interaction directly relates to its dispersion.	~ 6 - 9 mins		every 3rd silica final batch	
RPA Viscosity	Adapted ISO 13145	RPA Viscosity, as specified in ISO 13145, uses a multi-shear rate test method with an RPA to replace Mooney Viscometers when testing masterbatches.	~ 4 - 6 mins		every 2nd to 3rd masterbatch	
RPA Processability	Adapted ASTM D 6204	Processability testing is measured on unvulcanized compounds and assesses the specimen properties that correlate to key processing parameters.	~ 4 - 6 mins		at least one per run or on request	
RPA Cured compound performance	Adapted ASTM D 6601	Assessment of vulcanized compound properties for correlation to physical product performance.	~ 8 - 20 mins		at least one per run or on request	

Example configurations of online testing cells per mixing line type:

Online Testing Cells are equipped with the specific instruments to fit the purpose and cycle time of the corresponding mixing line.

Mixing line purpose	Online Testing Application	MDR 3000 Cell	D-RPA 3000 Cell	RD 3000 Cell
Carbon Black Masterbatch	Masterbatch production for PCR or TBR compounds		1 to 2	1
Carbon Black Final Mix	Final mixing of carbon black PCR ad TBR compounds	1	1	
Silica Masterbatch	Silica mixing / silanisation of mainly PCR compounds		2	1
Silica Final Mix	Final mixing of silica filled PCR compounds	2	1 to 2	0 to 1
Tandem or Big-tandem Line	Master and final mixing in one combined mixing pass and large batch sizes	2	1	1
Multi Purpose Line Black / Colored	Typically found in the technical rubber industry and at compounders	1 to 2	1	1

MonTech ONLINE TESTING CELL SYSTEMS

RETURN ON INVESTMENT CALCULATION

MonTech Online Testing Cells produce immediate tangible return-on-investment results upon implementation:

By installing a 6-Axis robot, automated line testing significantly reduces labor costs. This reduces operator involvement, shortens response times, and improves data quality.

Online Testing Cells and Laboratory Information Management Systems, and Mixing Management Software run synchronously.

Data acquired from both testing and processing systems allow users to statistically monitor and optimize compound and process parameters, leading to decreased scrap and re-work while increasing throughput.

Maximum return-on-investment is achieved when testing and processing are working in unison.

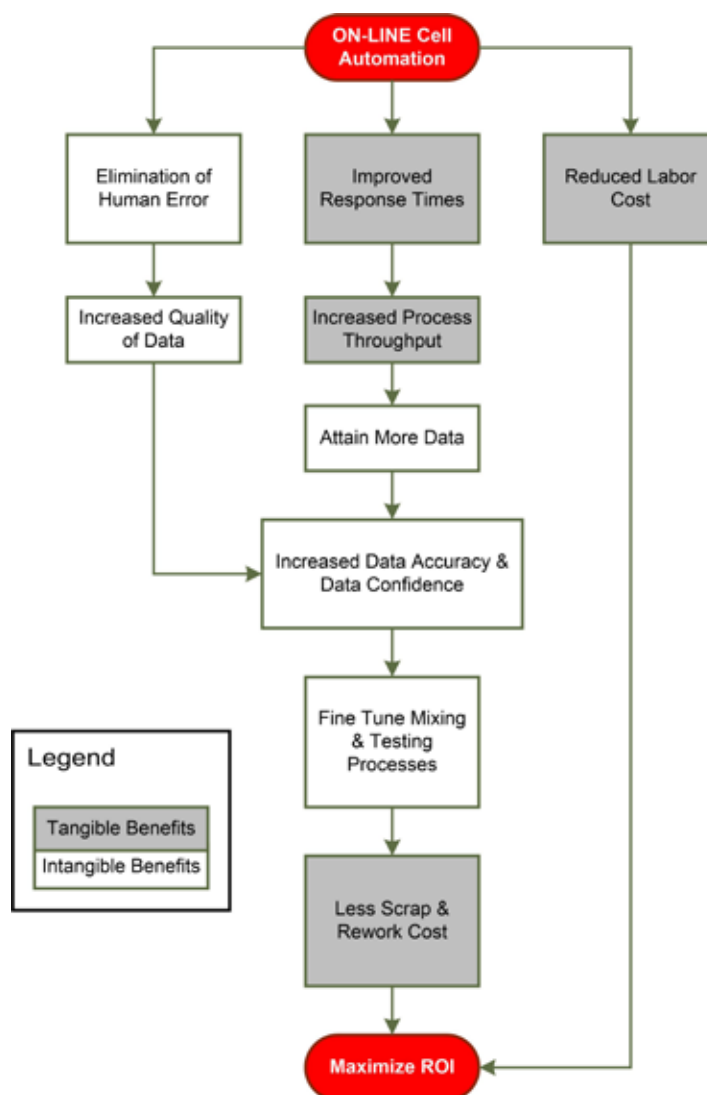

ENGINEERING AND CUSTOMIZATION

Online Testing Cells are built to match any specification, fit any process, and operate alongside any mixing line type:

MonTech Testing Cells are a flexible platform for easy customization and addition into any environment. Before the unit is assembled, comprehensive 3D models are created to virtually position the Testing Cell in your mixing room to ensure spacing requirements meet specification.

To ensure the best quality control on all products, all Testing Cells are manufactured in-house. In 2016, MonTech officially opened its new Manufacturing center in Buchen, Germany, exclusively for the design, production, testing, demonstration, and factory acceptance testing of Online Testing Cells.

Experience and evaluate the Online Testing Cell technology by contacting your representative and scheduling a live demonstration.

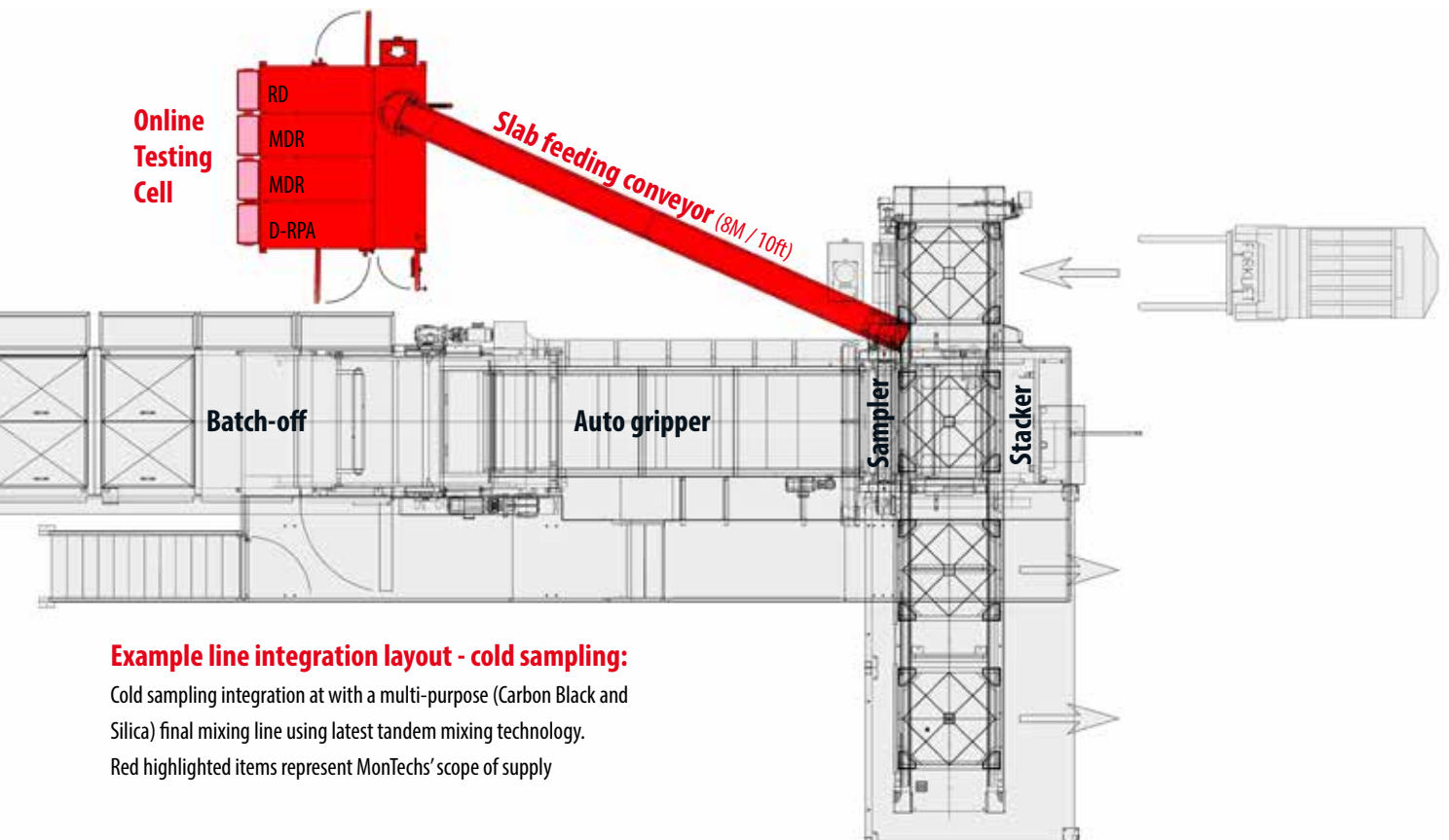

Online Testing Cell Systems

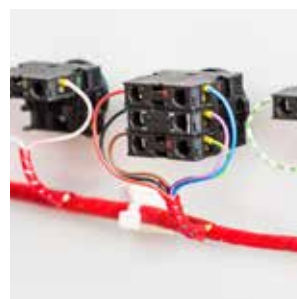
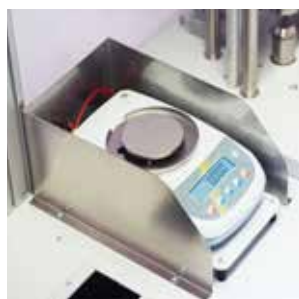
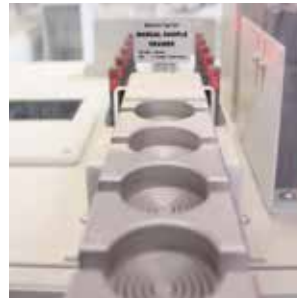

MonTech
System Solutions GmbH
Carl - Benz - Straße 11
D - 74722 Buchen / Germany

Phone: +49 (0) 06281 562230
Fax: +49 (0) 06281 562255
info@rubber-testing.com
www.rubber-testing.com

